

# RV Refrigerator

# 1852

MAR  
INE  
QUA  
LITY

## USER MANUAL

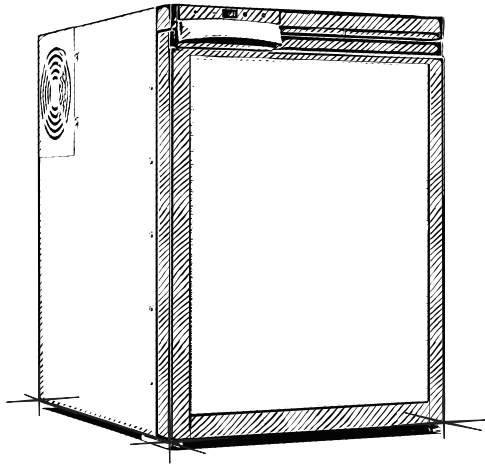

**Model**

**CR50**

# OWNER'S MANUAL

## **CONTENTS**

1.SAFETY INSTRUCTIONS -----	Page1
2.PRODUCT FEATURES -----	Page2
3.PRODUCT STRUCTURE -----	Page2
4.INSTALLATION -----	Page3
5.COMBINING FRIDGE/FREEZER COMPARTMENTS -----	Page4
6.REVERSE DOOR OPEN DIRECTION -----	Page5
7.FUNCTION AND OPERATION -----	Page6
8.CARE AND MAINTENANCE -----	Page7
9.TROUBLESHOOTING -----	Page8
10.WARRANTY-----	Page9
11.TECHNICAL INFORMATION -----	Page9
12.SMART CONTROL - APP INSTRUKSJON -----	Page10

## 1. SAFETY INSTRUCTIONS

### **WARNING!**

- Do not operate the appliance if it is visibly damaged.
- Do not block the gaps of the fridge with things like pin, wire, etc.
- Do not expose the appliance to rain or soak it in water.
- Do not place the appliance near naked flames or other heat sources (heaters, direct sunlight, gas ovens etc.)
- Do not store any explosive substances like spray cans with a flammable propellant.
- Ensure the supply cord is dry and not trapped or damaged. Do not locate multiple portable socket-outlets or portable power supplies at the rear of the appliance.
- Check the voltage specification on the type plate corresponds to that of the energy supply. The appliance is only to be used with the power supply unit provided with the appliance.
- Do not use electrical appliances inside the food storage compartments of the appliance, unless they are of the type recommended by the manufacturer.
- Once unpacked and before turning on, the appliance must be placed on a level surface for more than 6 hours.
- Make sure that the appliance stays horizontally when it is running. The tilt angle must be less than 5° for long time running and be less than 45° for short time running.
- Keep the ventilation openings in the unit casing or in the built-in structure free of obstacles.
- Keep the appliance stable on the ground or in the car; Do not drain upside down.

### **CAUTION!**

- Repairs may only be carried out by qualified personnel. Incorrect repair may cause danger. The lamp and supply cord must be replaced by the manufacturer or qualified persons.
- The installation of DC power in the boat must be handled by qualified electricians.
- Children shall not play with the appliance. Cleaning and user maintenance shall not be made by children without supervision.
- The appliance can be used by children aged from 8 years and above and persons with reduced physical, sensory or mental capabilities or lack of experience and knowledge if they've been given supervision or instruction concerning use of the device in a safe way and understand the hazards.

### **NOTICE!**

- Disconnect the power supply before each cleaning and maintenance and after every use.
- Do not use sharp tools to defrost; Do not damage the refrigerant circuit.
- Risk of child entrapment. Before you throw away your old refrigerator or freezer: take off the doors: leave the shelves in place so that children may not easily climb inside.
- Check if the cooling capacity of the appliance is suitable for storing the food or medicine. Food may only be stored in its original packaging or in suitable containers.
- If the appliance is left empty for long periods, switch off, defrost, clean, dry, and leave the door open to prevent mould developing within the appliance.
- The appliance is intended to be used in household and similar applications such as:

- Staff kitchen areas in shops, offices and other working environments;
- Camping, Farm houses and by clients in hotels, motels and other residential environments;
- Bed and breakfast type environments;
- Catering and similar non-retail applications.

 Please according to local regulations regarding disposal of the appliance for its flammable refrigerant and blowing gas.

## 2.PRODUCT FEATURES

- High-efficiency DC compressor and conversion module.
- CFC free and great heat insulation.
- Intelligent battery protection system prevents your vehicle from running out of battery.
- LED display control panel for temperature setting, dual fridge and freezer zone..
- Easy to install, fridge/freezer compartments can be combined, reversible door.

## 3.PRODUCT STRUCTURE

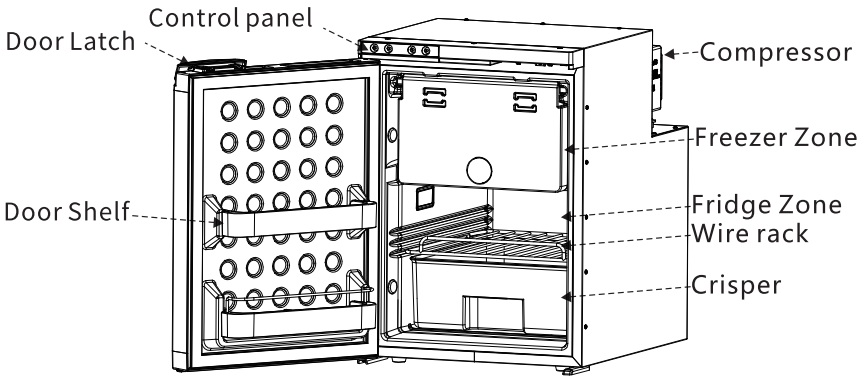

## 4. INSTALLATION

- 1) Ensure that the fridge is not damaged when opening the package after receiving the product. Any transportation damage could be reported to the place of purchase. Handle the product with the utmost care and attention.
- 2) Prepare the cabinet: leave some space around the refrigerator to keep good ventilation. (the back and top  $\geq 50\text{mm}$ , the side  $\geq 20\text{mm}$ ). Always keep the fridge on a horizontal surface and away from heat sources.

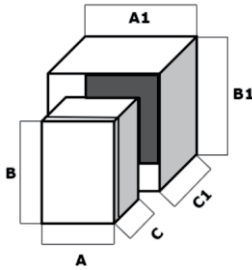

- 3) Connect to a power supply: connect the refrigerator to the vehicle 12/24VDC system directly, the minimal cable cross-section as per the below table based on the overall length of wire between the refrigerator and the battery.

It is highly recommended that the installation fridge is carried out by a qualified person. Enough free wire needed to be kept for moving the fridge into the cabinet.

Wire Length to Refrigerator	Wire Gauge
Maximum 6 m	14AWG
Maximum 11m	12AWG
Maximum 17m	10AWG

- 4) Push the fridge into the cabinet carefully to avoid scratching the floor, and the power cable should be kept loosen.

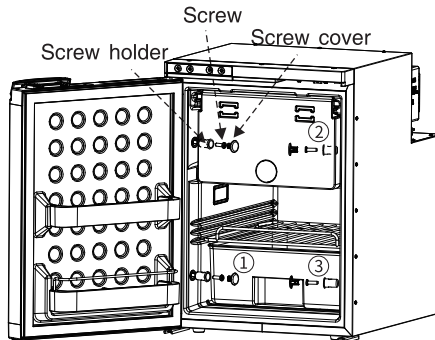

5) Mount the fridge with the cabinet wall: the screw holder is built in the side wall of the refrigerator, a hole needs to be drilled through the screw holder into the side metal panel with a screw (M5, 15mm minimal) and fix it on the wall; after that, use the screw cover to cover the hole. (If the refrigerator needs to be drilled through, it should be confirmed before leaving the factory. The screws are not included with the refrigerator.)

**Note:** except the method mentioned above, we also provide optional installation frame (standard frame or flush-mount frame) for a secure fit and a smart finish (as shown below).

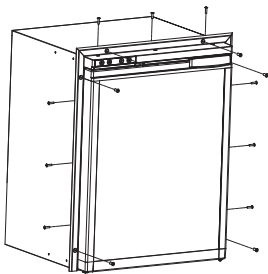

(Standard)

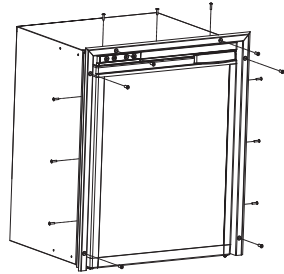

(Flush-mount)

6) Verify the installation: once the installation had been finished, check the continuity of the earth circuit and carry out all electrical safety testing provided for by current regulations. Protect and fix the cables in order to prevent accidental pulling of the cable from disconnecting it from the connections or coming into contact with hot parts with a temperature above 50° C or with sharp parts.

## 5.COMBINING FRIDGE/FREEZER COMPARTMENTS

Open the lid and pull out the divider horizontally.

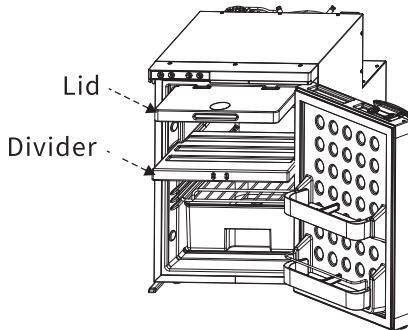

## 6. REVERSE DOOR OPEN DIRECTION

Reversible door that can be opened from left to right or from right to left. Follow the steps below if necessary :

1. Unscrew the bottom hinge and take off the door body (keep the fridge stable);
2. Unscrew and take off the door latch, and install it into the other side;
3. Move the top and bottom door axle to the other side, and install the door to the refrigerator; fasten the top and bottom door axles with the top and bottom hinges; screw the door with the hinges, the door opening direction is now reversed.

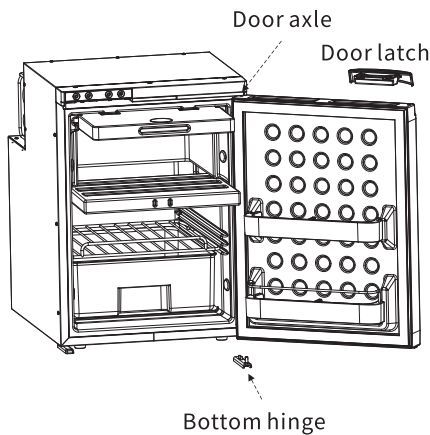
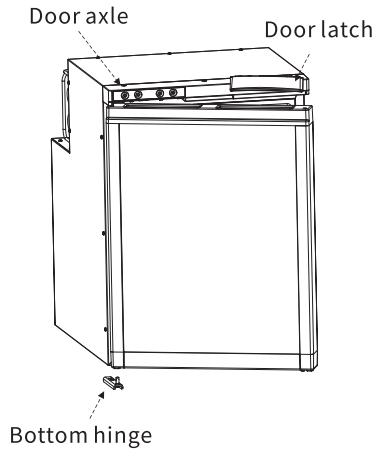

## 7.FUNCTION AND OPERATION

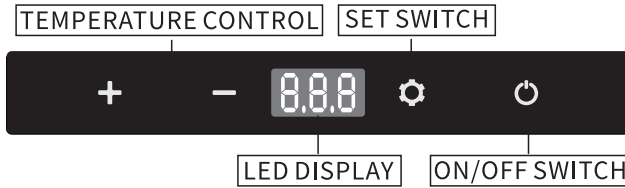

- **Power Supply:** DC 12V/24V or AC 100-240V power (using dedicated adapter).
- **Display Screen Initialization:** when the fridge is powered on, the buzzer will make a long beep, and the display will be on for two seconds then enter the normal operation.
- **Power ON/OFF:** press to switch ON/OFF.
- **Switch Refrigeration/freezer:** press to switch refrigerator (the screen will flash "rE") or freezer (the screen will flash "Fr").
- **Temperature Setting:** press **+** or **-** for temperature setting. The setting will be saved automatically after stopping operating for 4 seconds (Note: the temperature displayed is the current temperature of the compartment, it'll take a while to reach the set temperature.)
- **Battery Protection Mode:** under the running state, long press for 3 seconds until the left screen flashes, then press again to switch High, Medium and Low (\*Factory setting is High).



From left to right: High/Medium/Low.

### Voltage reference:

INPUT MODE	DC 12V		DC 24V	
	CUT OUT	CUT IN	CUT OUT	CUT IN
L	8.5V	10.9V	21.3V	22.7V
M	10.1V	11.4V	22.3V	23.7V
H	11.1V	12.4V	24.3V	25.7V







\* the voltage is theoretical value, there may be a deviation in different sceneries.

\* H should be set when the product is connected to car power, and M or L should be set when it is connected to a portable battery or other back-up battery.

- **Temperature Unit Setting:** switch off the fridge, long press for 3 seconds until displays E1, and switch to E5 by pressing again, then press **+** or **-** to switch Celsius or Fahrenheit. (\*Factory setting is °C.)
- **Reset:** switch off the fridge, long press for 3 seconds until displays E1, under E1 mode, long press **+** **-** at the same time for seconds to reset the settings.



• **Recommended temperature for common food:**

						
Drinks	Fruits	Vegetable	Delicatessen	Wine	Ice cream	Meat
5°C/41°F	5~8°C/41~46°F	3~10°C/37~50°F	4°C/39°F	10°C/50°F	-10°C/14°F	-18°C/0°F

## 8. CARE AND MAINTENANCE

### ■ Cleaning:

- Switch off and unplug the device first to avoid electric shock.
- Use wet cloth to clean the device and dry it.
- Do not soak the fridge in water and do not wash it directly.
- Do not use abrasive cleaning agents during cleaning as these can damage the device.



### ■ Storage:

If the device will not be in use for a long time, please follow the instruction:

- Switch off and unplug the device.
- Take out all the items stored in the device.
- Wipe off excess water with a soft rag.
- Put the fridge in a cool and dry place.
- Leave the lid slightly open to prevent odors from forming.
- Recommended storage environment:  
ambient temperature: 25°C, ambient humidity: ≤ 75%.

### ■ Defrosting:

Humidity can form frost in the interior of the cooling device or on the evaporator. This reduces the cooling capacity. Defrost the device in good time to avoid this.

- Switch off and unplug the device first to avoid electric shock.
- Take out all the items stored in the device.
- Keep the lid open.
- Wipe off the defrosted water.



**Never use hard or pointed tools to remove ice or to loosen objects which have frozen in place.**

## 9.TROUBLESHOOTING

Issues	Cause/Suggestions
<b>Refrigerator does not work</b>	<ul style="list-style-type: none"> <li>• Check if the switch is on.</li> <li>• Check if the plug and socket are connected well.</li> <li>• Check if the fuse has been burnt.</li> <li>• Check if the power supply is malfunctioned.</li> <li>• Switch on/off the fridge frequently may cause start delay of the compressor.</li> </ul>
<b>Refrigerator compartments are too warm</b>	<ul style="list-style-type: none"> <li>• The door is opened frequently.</li> <li>• A large amount of warm or hot food was stored recently.</li> <li>• The refrigerator has been disconnected for a long time.</li> </ul>
<b>Food is frozen</b>	<ul style="list-style-type: none"> <li>• The temperature was set too low.</li> </ul>
<b>There is "water flow" noise from inside the refrigerator</b>	<ul style="list-style-type: none"> <li>• It's a normal phenomenon, caused by the flow of refrigerant.</li> </ul>
<b>There are waterdrops around the refrigerator casing or door gap</b>	<ul style="list-style-type: none"> <li>• It's a normal phenomenon, the moisture will condense to water when it touches a cold surface of the refrigerator.</li> </ul>
<b>The compressor is slightly noisy when starting</b>	<ul style="list-style-type: none"> <li>• It's a normal phenomenon, the noise will be reduced after the compressor works stably.</li> </ul>
<b>Code F1 displayed</b>	<ul style="list-style-type: none"> <li>• Possible cause: low voltage to fridge. Adjust the battery protection from High to Medium or from Medium to Low.</li> </ul>
<b>Code F2 displayed</b>	<ul style="list-style-type: none"> <li>• Possible cause: condenser fan is overloaded. Disconnect power to fridge for 5 minutes &amp; re-start. If the code shows again, contact manufacturer for service.</li> </ul>
<b>Code F3 displayed</b>	<ul style="list-style-type: none"> <li>• Possible cause: the compressor starts too frequently. Disconnect power to fridge for 5 minutes &amp; re-start. If the code shows again, contact manufacturer for service.</li> </ul>
<b>Code F4 displayed</b>	<ul style="list-style-type: none"> <li>• Possible cause: compressor not kicking in. Disconnect power to fridge for 5 minutes &amp; re-start. If the code shows again, contact manufacturer for service.</li> </ul>
<b>Code F5 displayed</b>	<ul style="list-style-type: none"> <li>• Possible cause: overheating of the compressor &amp; electronics. Disconnect power to fridge for 5 minutes &amp; re-start. If the code shows again, contact manufacturer for service.</li> </ul>
<b>Code F6 displayed</b>	<ul style="list-style-type: none"> <li>• Possible cause: no parameter can be detected by the controller. Disconnect power to fridge for 5 minutes &amp; re-start. If the code shows again, contact manufacturer for service.</li> </ul>
<b>Code F7 or F8 displayed</b>	<ul style="list-style-type: none"> <li>• Possible cause: temperature sensor is faulty. Contact manufacturer for service.</li> </ul>

## 10.WARRANTY

If the device gets malfunctional, limited warranty will be provided for 1 year from the date of purchase, except following situations:

- Contrived damage.
- Damage caused by force majeure such as earthquake, conflagration, etc.
- Damage from inappropriate use or violating this instruction.
- Damage or malfunction caused by disassembling.

## 11.TECHNICAL INFORMATION

MODEL	CR50
RATED VOLTAGE	DC12/24V or AC100~240V(using dedicated adapter)
RATED POWER	60W
CAPACITY	50L/1.7 cu.ft.
NOISE	≤45dB
TEMPERATURE SETTING RANGE	Refrigeration: 0~8°C (32~46°F) Freezer: -12~-20°C (10~-4°F)
CLIMATE CATEGORY	T/ST/N/SN
DIMENSIONS(L*W*H)	380*500*534mm 14 15/16 *19 11/16 *21 1/16 inch
NET WEIGHT	16.9kg/37.3lb

\*Due to product improvement, the technical information might be different from actual information, please refer to the rating label on the product.

## 12. SMART CONTROL - APP INSTRUKSJON

**First Step:** Turn on the Bluetooth on your smart device; start the APP and click "Search" to find nearby fridges.

**Second Step:** Click fridge icon for Bluetooth pairing (the APP will prompt you to pair the fridge by pressing the set button  on the fridge's control panel when connecting the fridge for the first time). After pairing, the APP will switch to the main interface allowing you to control the fridge.

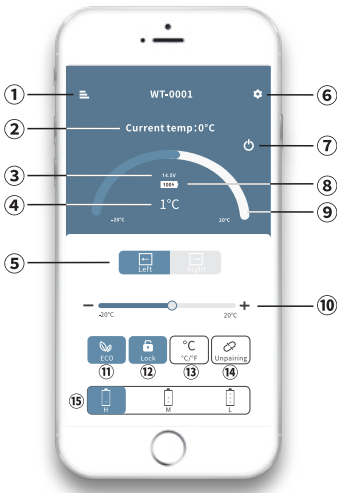

- ① MENU
- ② Current temperature
- ③ Current battery
- ④ Target temperature
- ⑤ Switch Left/Right compartment
- ⑥ SET
- ⑦ ON/OFF
- ⑧ Current battery
- ⑨⑩ Temperature control
- ⑪ ECO(Energy-saving) / MAX(Fast-cooling)
- ⑫ Lock / Unlock
- ⑬ Celsius / Fahrenheit
- ⑭ Unpairing the device and return to search
- ⑮ Battery protection mode: High/Medium/Low

### Note:

\*Click the lock icon  on the APP to lock/unlock the control panel on the fridge, if locked, the fridge can only be controlled by the APP.

## Downloading the "CAR FRIDGE FREEZER" Application



IOS



Android

Scan the QR code on the left or search for the "CAR FRIDGE FREEZER" APP in the APP Store (for Apple devices) or Google Store (for Android devices).